

SG 1014

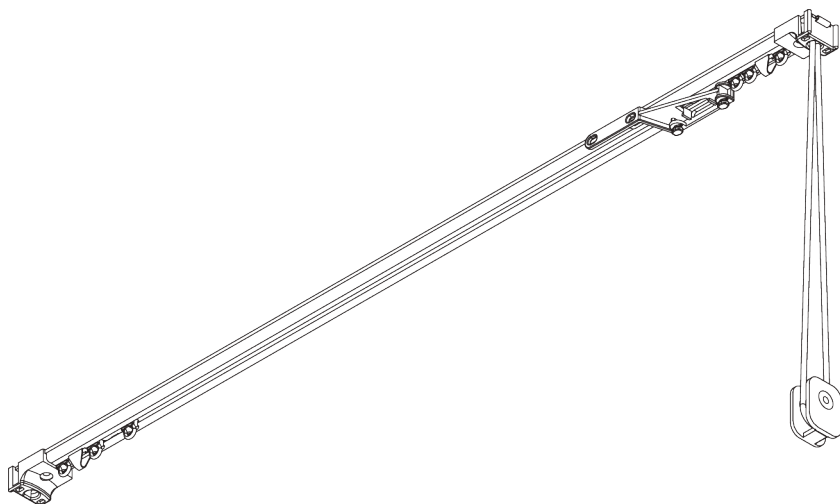
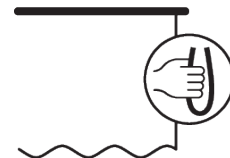

INFORMATION PRODUIT

- **Mode de commande:** Tirage cordon
- **Gamme:** S
- **Installation:** Plafond
- **Couleurs:** Blanc RAL 9016 ou Aluminium, couleurs spéciales possibles
- **Tissus:** Se référer à la collection tissu Silent Gliss

Caractéristiques:

- Profil prépercé
- Cintrable
- Outil d'installation SG 7550

SPÉCIFICATION SYSTÈME

A. DIMENSIONS SYSTÈME

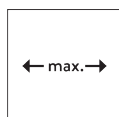

6 m

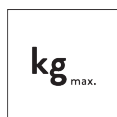

11 kg

Poids maximum du rideau

	2 m	4 m	6 m
	8	7	6
	11	10	8
	5	4	-
	6	5	-
	3	2	-
	5	4	-
	(kg max.)		

B. PROFIL

Profil et information de cintrage

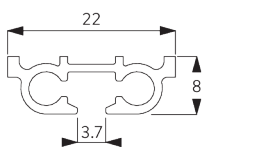

SG 1014p

Profil

✓ Rayon:
20 cm

C. PRISE DE MESURE

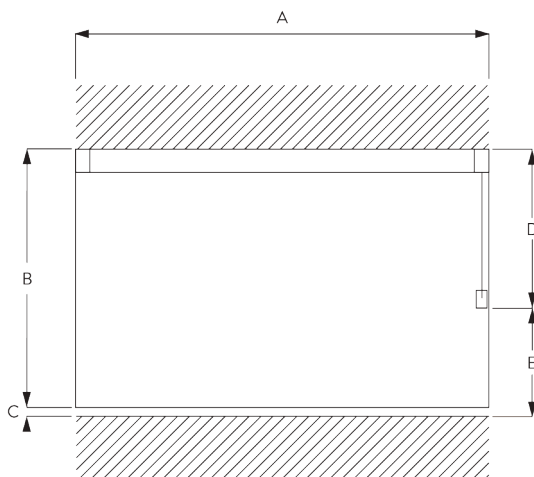

A: Largeur système

B: Hauteur système

C: Distance entre bas du rideau et le sol

D: Hauteur corde

E: Sécurité SG 10731. min. 150 cm du sol

INSTALLATION

A. INSTRUCTION DE POSE

Pour des informations détaillées, se référer au site web Silent Gliss.

Points de fixation

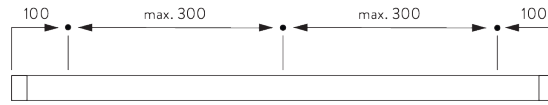

Outils d'installation

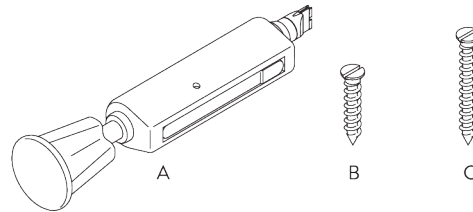

A: Outil Center SG 7550 Tool

B: Vis SG 3019 / 12 mm

C: Vis SG 3025 / 18 mm

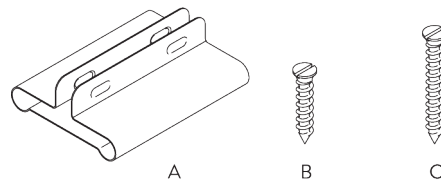

A: Outil de protection du profil SG 7002

B: Vis SG 3019 / 12 mm

C: Vis SG 3025 / 18 mm

B. FIXATION PLAFOND

Fixation directe dans le bois

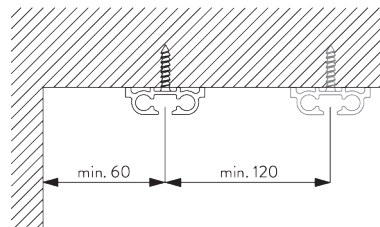

Support SG 3114

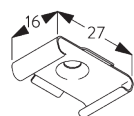
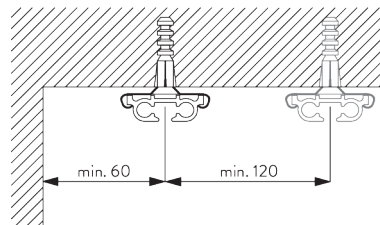

SG 3114

Support plafond

ACCESSOIRES

A. ACCESSOIRES STANDARDS

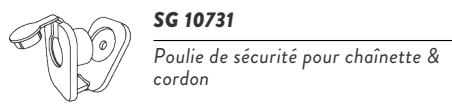
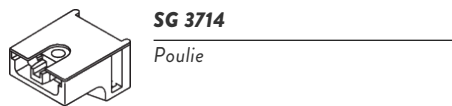
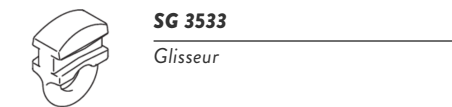
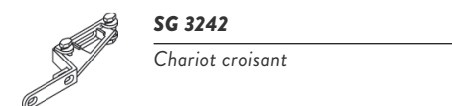
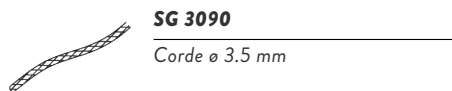
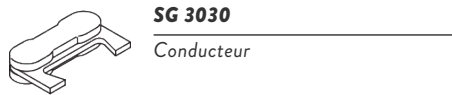
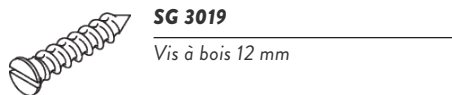
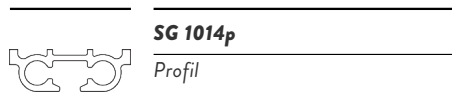

B. ACCESSOIRES EN OPTION

